

CUMULO OVERVIEW

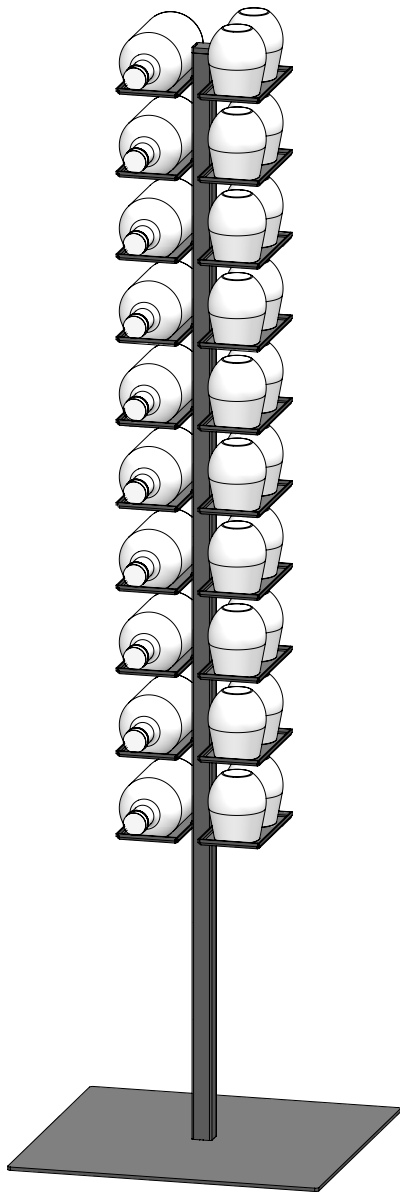

Cumulo STAND
See page 3

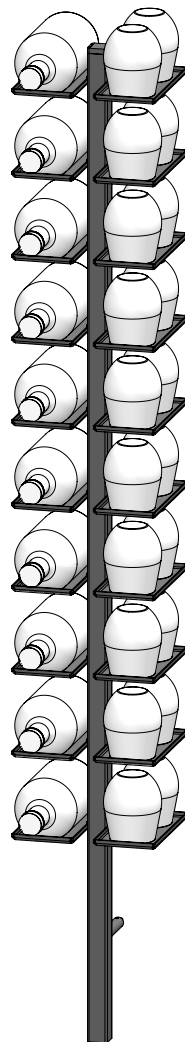

Cumulo WALL
See page 5

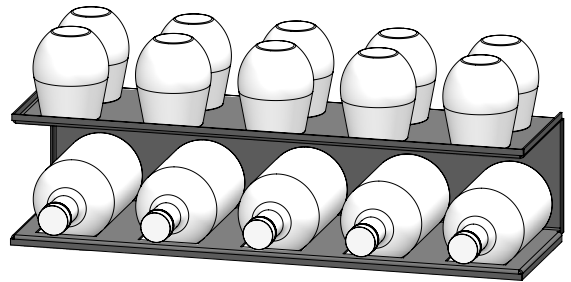

Cumulo HORIZON
See page 7

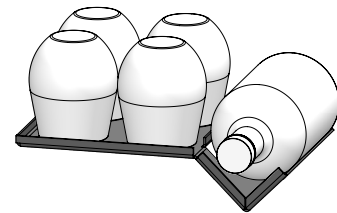

Cumulo BIRD
See page 9

CUMULO STAND

Freestanding installation

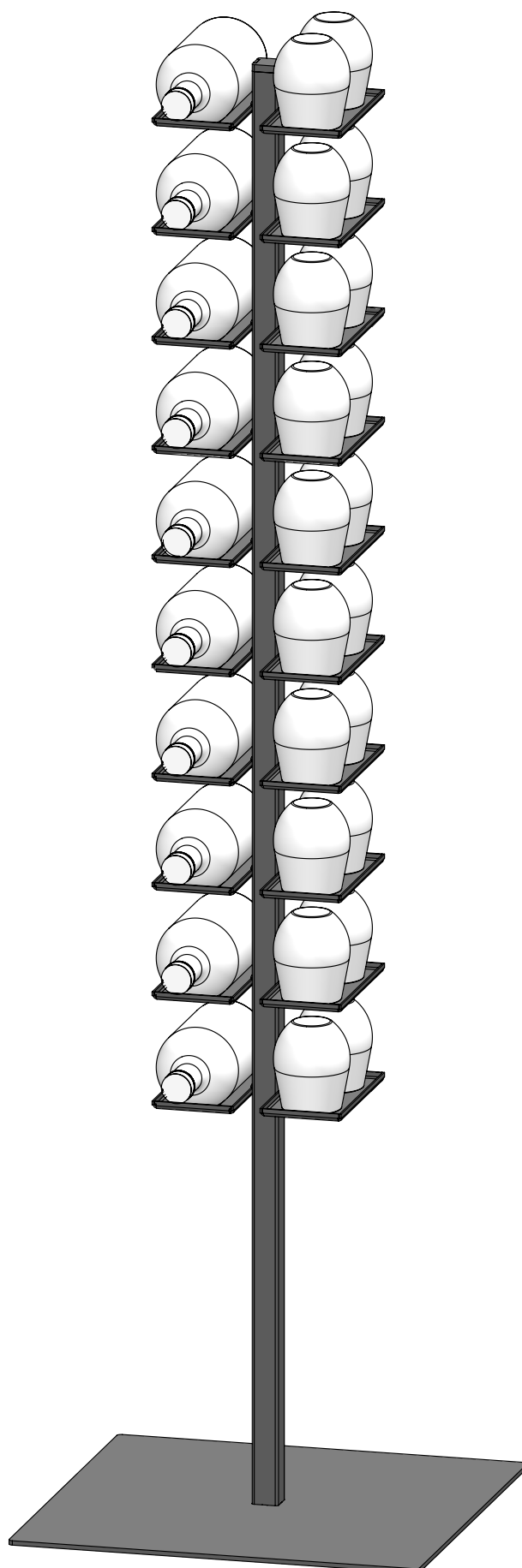

CUMULO STAND

Freestanding installation

Technical information

Product dimensions WxDxH 470 x 470 x 1653 mm

Net weight 17,6 kg

Max. load capacity 20 kg

(Only use empty bottles!)

3 options:

- Full Glass Capacity of 40 glasses
- Full Bottle Capacity of 20 bottles
- Mixed Capacity of 10 bottles and 20 glasses

Matching AQUALEX bottle: Glass bottle 0,7l or 0,5l

Matching AQUALEX Glass: Tumbler glass

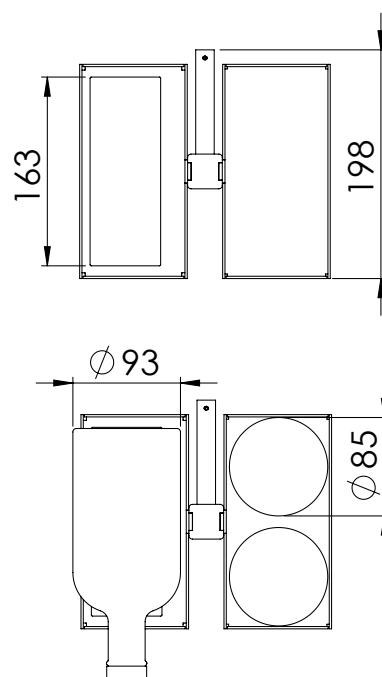
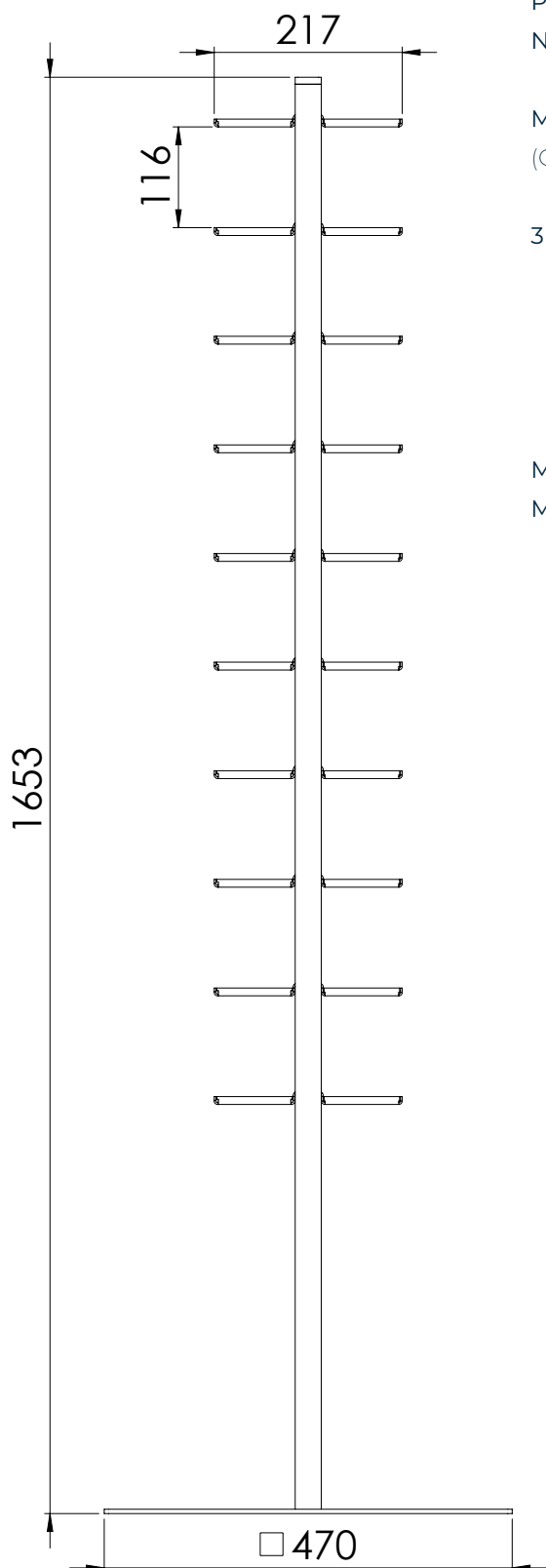

All dimensions in mm

CUMULO WALL

Wall installation

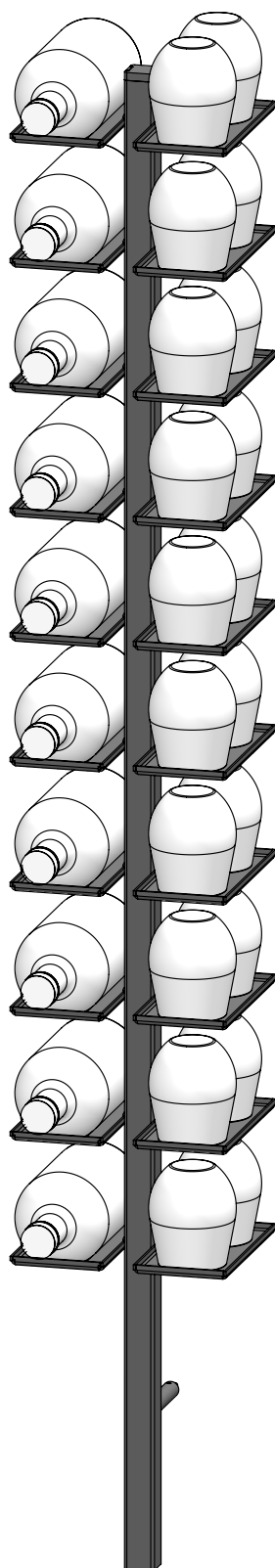

CUMULO WALL

Wall installation

Technical information

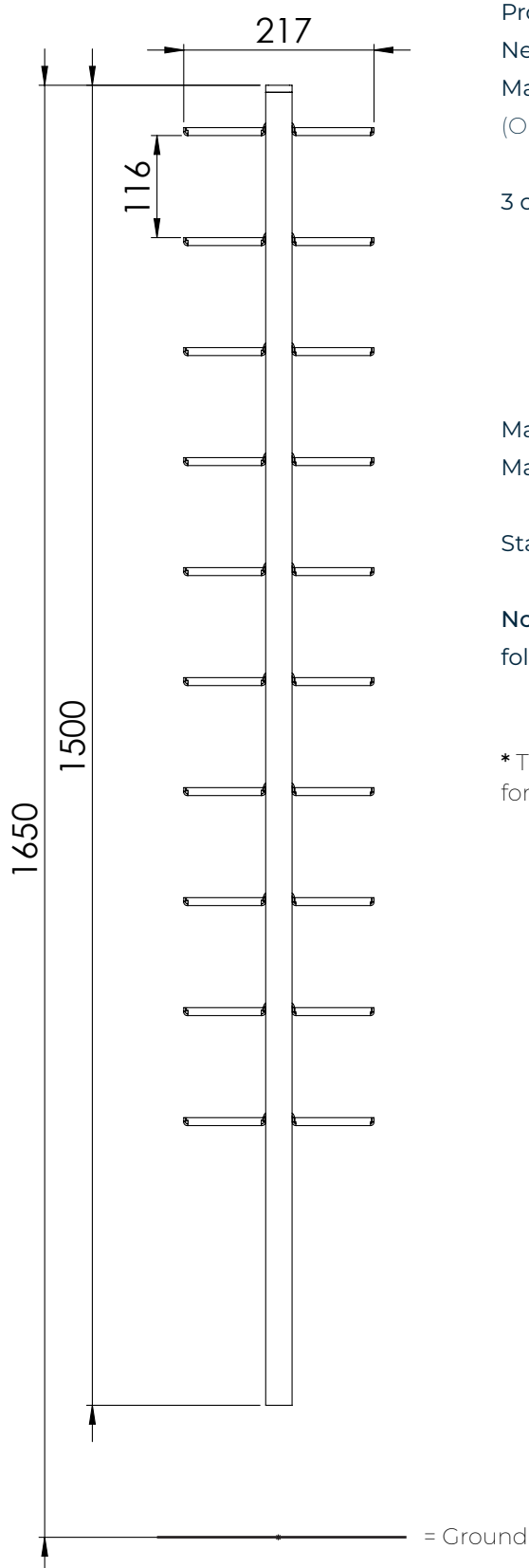

Product dimensions WxDxH	217 x 198 x 1650 mm
Net weight	8,8 kg
Max. load capacity (Only use empty bottles!)	20 kg

3 options:

- Full Glass Capacity of 40 glasses
- Full Bottle Capacity of 20 bottles
- Mixed Capacity of 10 bottles and 20 glasses

Matching AQUALEX bottle	Glass bottle 0,7l or 0,5l
Matching AQUALEX Glass	Tumbler glass

Standard installation 2x dowel + screw $\varnothing 5$ mm*

No installation possible with following wall types
Plasterboard, Gypsum block, Cellular concrete AAC2 (G2)

* The customer guarantees a wall that is sufficiently load-bearing for a weight of at least 30 kg.

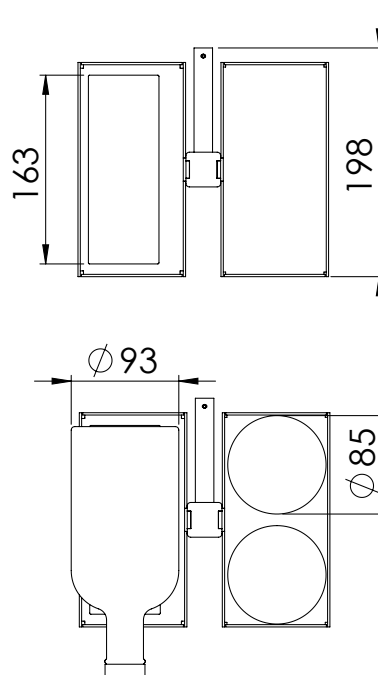

All dimensions in mm



CUMULO HORIZON

Wall installation

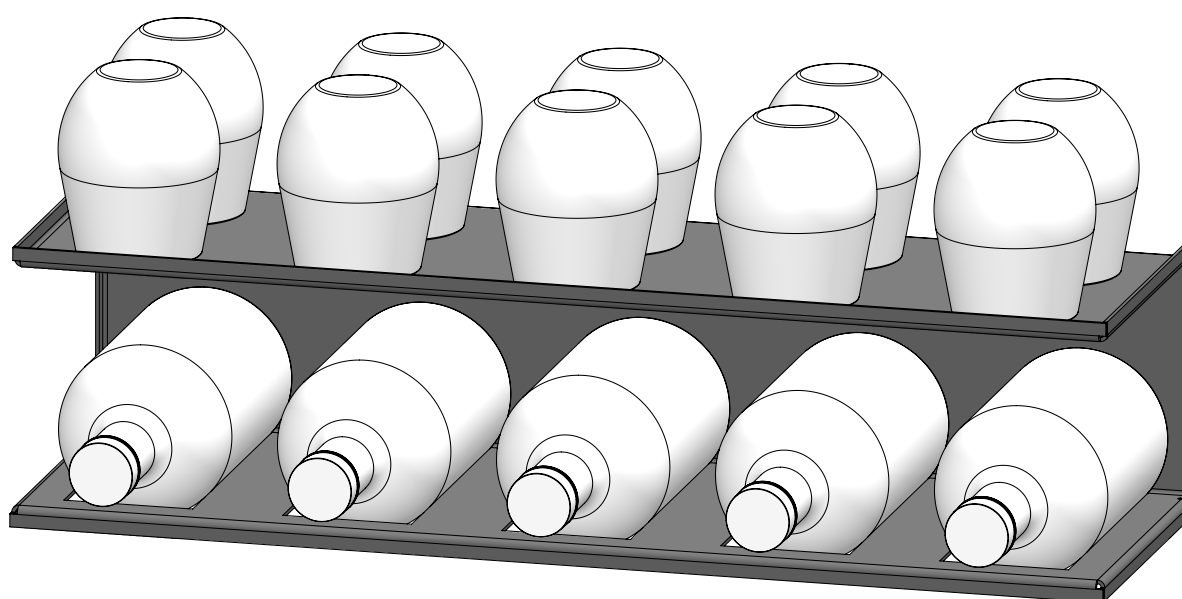

CUMULO HORIZON

Wall installation

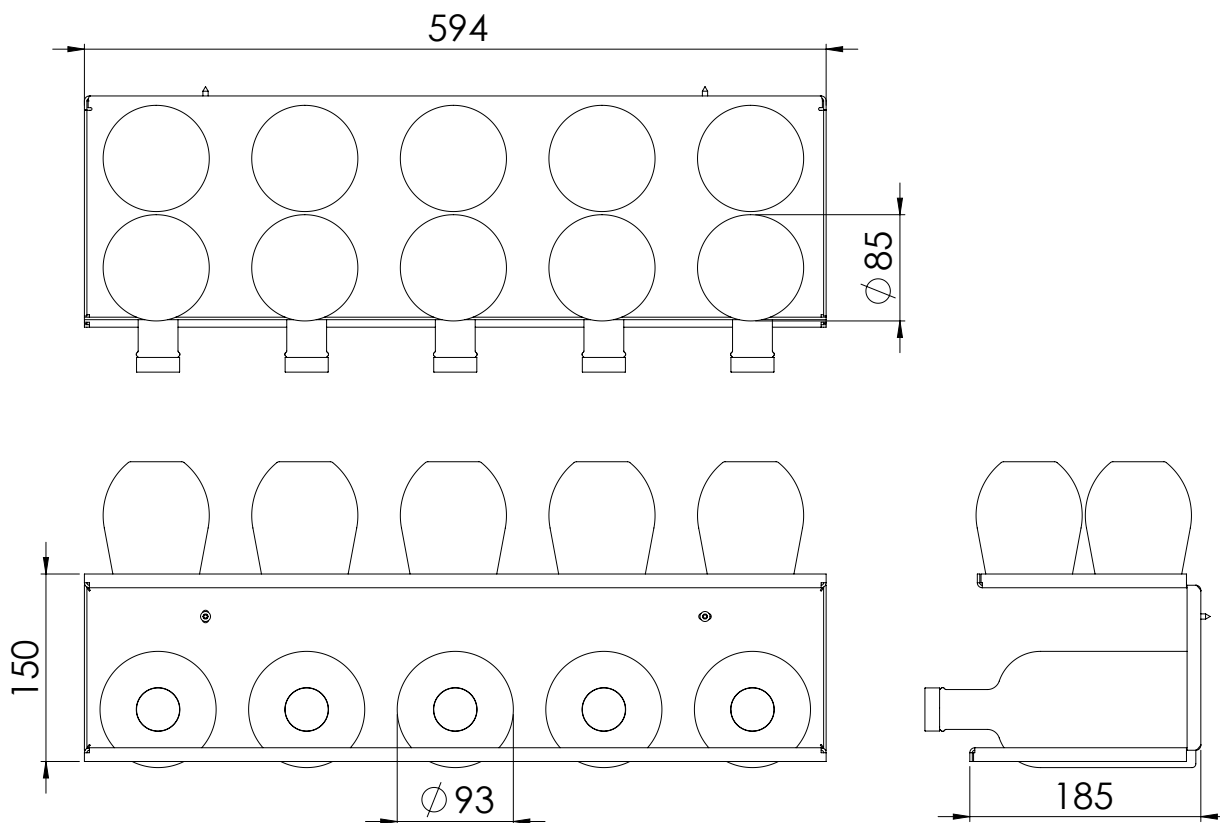

Technical information

Product dimensions WxDxH	594 x 185 x 150 mm
Net weight	3,9 kg
Max. load capacity (Only use empty bottles!)	10 kg
Suitable for	10 glasses and 5 bottles
Matching AQUALEX bottle	Glass bottle 0,7l or 0,5l
Matching AQUALEX Glass	Tumbler glass
Standard installation	2x dowel + screw \varnothing 5 mm*

* The customer guarantees a wall that is sufficiently load-bearing for a weight of at least 15 kg.

All dimensions in mm

CUMULO BIRD

Wall installation

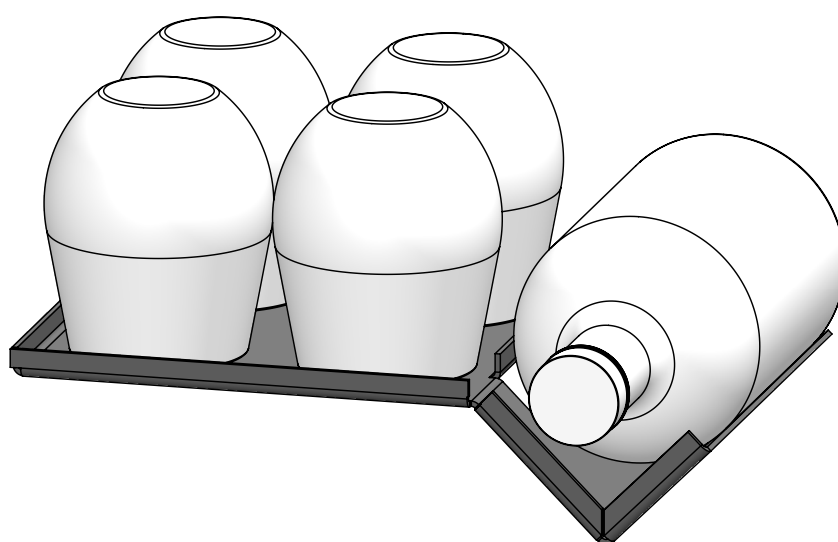

CUMULO BIRD

Wall installation

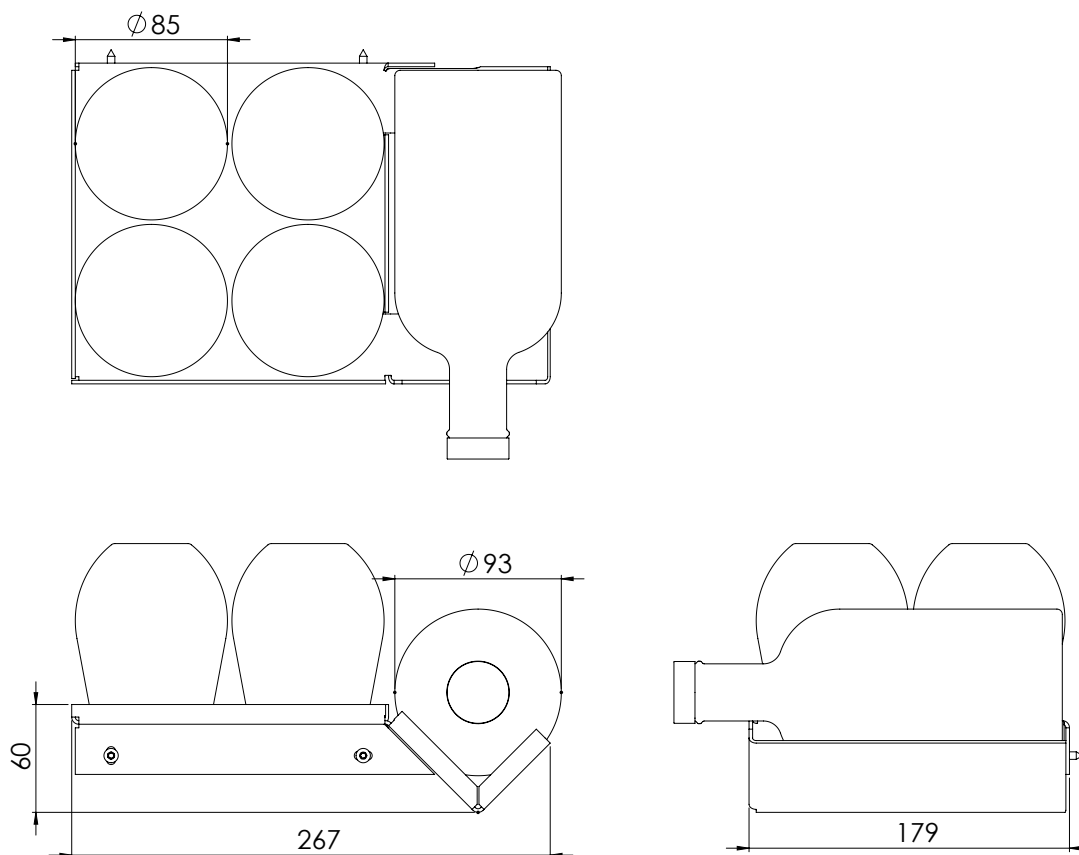

Technical information

Product dimensions WxDxH	267 x 179 x 60 mm
Net weight	0,96 kg
Max. load capacity (Only use empty bottles!)	5 kg
Suitable for	4 glasses and 1 bottle
Matching AQUALEX bottle	Glass bottle 0,7l or 0,5l
Matching AQUALEX Glass	Tumbler glass
Standard installation	2x dowel + screw \varnothing 5 mm*

* The customer guarantees a wall that is sufficiently load-bearing for a weight of at least 7 kg.

All dimensions in mm